



**OWNER'S / OPERATOR'S
MANUAL**



**READ THIS MANUAL CAREFULLY!
It contains important safety information.**

YDRA
4 STROKE GOLF CAR

 **WARNING**

The engine exhaust from this product contains chemicals known to the State of California to cause cancer, birth defects or other reproductive harm.

YAMAHA

LIT-CALIF-65-01

INTRODUCTION

Congratulations on your purchase of a Yamaha golf car. This manual contains information you will need for proper operation, maintenance, and care of your golf car. A thorough understanding of these simple instructions will help you to obtain maximum enjoyment from your new Yamaha.

If you have any questions about the operation or maintenance of your golf car, please consult a Yamaha dealer.

YAMAHA GOLF-CAR COMPANY

YDRA OWNER'S/OPERATOR'S MANUAL

**© 2012 by Yamaha Golf-Car Company
3rd Edition**

**All rights reserved. Any reprinting
or unauthorized use without the
written permission of
Yamaha Golf-Car Company
is expressly prohibited.**

Printed in U.S.A.

LIT-19626-11-13

IMPORTANT MANUAL INFORMATION

Particularly important information is distinguished in this manual by the following notations:



This is the safety alert symbol. It is used to alert you to potential personal injury hazards. Obey all safety messages that follow this symbol to avoid possible injury or death.

WARNING

A **WARNING** indicates a potentially hazardous situation which, if not avoided, could result in death or serious injury.

NOTICE

A **NOTICE** indicates special precautions that must be taken to avoid damage to the vehicle or other property.

TIP

A **TIP** provides key information to make procedures easier or clearer.

TIP

Yamaha continually seeks advancements in product design and quality; therefore, while this manual contains the most current product information available at the time of printing, there may be minor discrepancies between your golf car and this manual. If you have any questions concerning this manual, please consult your Yamaha dealer.

WARNING

Read and understand this manual completely before operating your golf car. This manual should be considered a permanent part of your golf car and should remain with the car when resold.

CONTENTS

WARRANTY

1

IMPORTANT LABELS

2

OPERATOR SAFETY

3

SAFETY CONSIDERATIONS

4

CONTROLS

5

PRE-OPERATION CHECKS

6

OPERATION

7

MAINTENANCE

8

STORAGE

9

SPECIFICATIONS

10

WIRING

11

WARRANTY

LIMITED 4-YEAR GOLF CAR LIMITED WARRANTY

1

Yamaha Golf-Car Company hereby warrants that any new YDRA gas or YDRE electric Yamaha golf car purchased from an authorized Yamaha golf car dealer in the United States will be free from defects in material and workmanship for FOUR years from date of purchase, subject to the stated limitations.

DURING THE PERIOD OF WARRANTY any authorized Yamaha golf car dealer will, free of charge, repair or replace, at Yamaha's option, any part adjudged defective by Yamaha due to faulty workmanship or material from the factory. Parts used in warranty repairs will be warranted for the balance of the vehicle's warranty period. All parts replaced under warranty become property of Yamaha Golf-Car Company.

GENERAL EXCLUSIONS from this warranty shall include any failures caused by:

- Abnormal strain, neglect, or abuse, including lack of proper maintenance, and use contrary to the Owner's/Operator's Manual instructions.
- Accident or collision damage.
- Installation of parts or accessories that are not original equipment.
- Fading, rust, or deterioration due to exposure or ordinary wear and tear.
- Modifications or alterations that affect the car's condition, operation, performance, or durability, or which makes the car serve a purpose other than use as a two-person, golf course vehicle.
- Damage due to improper transportation.
- Acts of God, i.e. lightning, hail damage, flooding, fire, etc.

WARRANTY COVERAGE:

- Year 1:** The first year of warranty shall cover the entire vehicle except for the Specific Exclusions below.
- Year 2:** The second year exclusions are the YDRA battery, body parts, seats, mats, bumper assembly, bag carrier, scorecard holder, trim, and the Specific Exclusions below.
- Year 3:** The third year exclusions include the second year exclusions, plus the control cables and electrical system (except electronic speed controller, battery charger, and electric motor), and the Specific Exclusions below.
- Year 4:** The fourth year of the warranty covers only the electric motor, speed controller, battery charger, and transaxle on the YDRE and the engine, clutch system (except drive belt), and transaxle on the YDRA.

SPECIFIC EXCLUSIONS: Specific exclusions from this warranty shall include the following:

- Electric car batteries, which are covered under a separate warranty.
- Any parts replaced due to normal wear or routine maintenance, including oil and air filter elements, tire wear, spark plugs, starter and clutch drive belts.

- Any charges incurred in transporting a golf car or charger to and from an authorized Yamaha golf car dealer for service or in performing field service are also excluded from this warranty.
- Gasoline powered golf car starting batteries on vehicles equipped with a golf course GPS device, or any other device with a parasitic current draw, unless the vehicle is equipped from the factory with an optional deep cycle starting battery.

THE CUSTOMER'S RESPONSIBILITY under this warranty shall be to:

- Operate and maintain the golf car and charger as specified in the appropriate Owner's/Operator's Manual;
- Give notice to an authorized Yamaha golf car dealer of any and all apparent defects within ten (10) days after discovery, and make the vehicle or charger available at that time for inspection and repairs by the dealer's authorized representative.

WARRANTY TRANSFER: Any transfer of warranty must take place within the first three years of the original in-service date of the vehicle. The vehicle must be re-registered by an authorized Yamaha Golf-Car Dealer within 30 days of transfer. A fee may be charged for the transfer of the warranty.

YAMAHA GOLF-CAR COMPANY MAKES NO OTHER WARRANTY OF ANY KIND, EXPRESSED OR IMPLIED. ALL IMPLIED WARRANTIES OF MERCHANTABILITY AND FITNESS FOR A PARTICULAR PURPOSE WHICH EXCEED THE OBLIGATIONS AND TIME LIMITS STATED IN THIS WARRANTY ARE HEREBY DISCLAIMED BY YAMAHA GOLF-CAR COMPANY AND EXCLUDED FROM THIS WARRANTY.

SOME STATES DO NOT ALLOW LIMITATIONS ON HOW LONG IMPLIED WARRANTY LASTS, SO THE ABOVE LIMITATION MAY NOT APPLY TO YOU. ALSO EXCLUDED FROM THIS WARRANTY IS ANY INCIDENTAL OR CONSEQUENTIAL DAMAGES INCLUDING LOSS OF USE. SOME STATES DO NOT ALLOW THE EXCLUSION OR LIMITATION OF INCIDENTAL OR CONSEQUENTIAL DAMAGES, SO THE ABOVE EXCLUSION MAY NOT APPLY TO YOU.

THIS WARRANTY GIVES YOU SPECIFIC LEGAL RIGHTS, AND YOU MAY ALSO HAVE OTHER RIGHTS, WHICH VARY, FROM STATE TO STATE.

Yamaha Golf-Car Company,
NEWNAN, GEORGIA 30265-1320

EFFECTIVE DATE: 6/1/11

LIT-13710-01-12

WARRANTY

CALIFORNIA EMISSION CONTROL WARRANTY STATEMENT YOUR WARRANTY RIGHTS AND OBLIGATIONS

1

The California Air Resources Board and Yamaha Golf-Car Company are pleased to explain the emissions control system warranty on your 2010 or later small off-road engine (SORE) vehicle. In California, new SORE vehicles must be designed, built and equipped to meet the State's stringent anti-smog standards. Yamaha Golf-Car Company must warrant the EECS on your SORE vehicle for the period of time listed below provided there has been no abuse, neglect or improper maintenance of your SORE vehicle.

Your EECS may include parts such as the carburetor, fuel-injection system, the ignition system, catalytic converter, fuel tanks, fuel lines, fuel caps, valves, canisters, filters, vapor hoses, clamps, connectors, and other associated emission-related components.

Where a warrantable condition exists, Yamaha Golf-Car Company will repair your SORE vehicle at no cost to you including diagnosis, parts and labor.

MANUFACTURER'S WARRANTY COVERAGE:

This emissions control system is warranted for two years. If any emission-related part on your equipment is defective, the part will be repaired or replaced by Yamaha Golf-Car Company.

OWNER'S WARRANTY RESPONSIBILITIES:

As the SORE vehicle owner, you are responsible for performance of the required maintenance listed in your owner's manual. Yamaha Golf-Car Company recommends that you retain all receipts covering maintenance on your SORE vehicle, but Yamaha Golf-Car Company cannot deny warranty solely for the lack of receipts.

As the SORE vehicle owner, you should however be aware that Yamaha Golf-Car Company may deny you warranty coverage if your SORE vehicle or a part has failed due to abuse, neglect, or improper maintenance or unapproved modifications.

You are responsible for presenting your SORE vehicle to Yamaha Golf-Car Company's distribution center or service center as soon as the problem exists. The warranty repairs should be completed in a reasonable amount of time, not to exceed 30 days. If you have a question regarding your warranty coverage, you should contact YGC Service at 1-866-747-4027.

GENERAL EMISSIONS WARRANTY COVERAGE:

Yamaha Golf-Car Company warrants to the ultimate purchaser and each subsequent purchaser that the SORE vehicle is:

Designed, built and equipped so as to conform with all applicable regulations; and

Free from defects in materials and workmanship that cause the failure of a warranted part to be identical in all material respects to that part as described in Yamaha Golf-Car Company's application for certification.

The warranty period begins on the date the SORE vehicle is delivered to an ultimate purchaser or first placed into service. The warranty period is two years.

Subject to certain conditions and exclusions as stated below, the warranty on emission-related parts is as follows:

1. Any warranted part that is not scheduled for replacement as required maintenance in the written instructions supplied, is warranted for the warranty period stated above. If the part fails during the period of warranty coverage, the part will be repaired or replaced by Yamaha Golf-Car Company according to subsection (4) below. Any such part repaired or replaced under warranty will be warranted for the remainder of the period.
2. Any warranted part that is scheduled only for regular inspection in the written instructions supplied is warranted for the warranty period stated above. Any such part repaired or replaced under warranty will be warranted for the remaining warranty period.
3. Any warranted part that is scheduled for replacement as required maintenance in the written instructions supplied is warranted for the period of time before the first scheduled replacement date for that part. If the part fails before the first scheduled replacement, the part will be repaired or replaced by Yamaha Golf-Car Company according to subsection (4) below. Any such part repaired or replaced under warranty will be warranted for the remainder of the period prior to the first scheduled replacement point for the part.
4. Repair or replacement of any warranted part under the warranty provisions herein must be performed at a warranty station at no charge to the owner.
5. Notwithstanding the provisions herein, warranty services or repairs will be provided at all of our distribution centers that are franchised to service the subject engines or equipment.
6. The SORE vehicle owner will not be charged for diagnostic labor that is directly associated with diagnosis of a defective, emission-related warranted part, provided that such diagnostic work is performed at a warranty station.
7. Yamaha Golf-Car Company is liable for damages to other engine or equipment components proximately caused by a failure under warranty of any warranted part.

WARRANTY

1

8. Throughout the SORE vehicle warranty period stated above, Yamaha Golf-Car Company will maintain a supply of warranted parts sufficient to meet the expected demand for such parts.
9. Any replacement part may be used in the performance of any warranty maintenance or repairs and must be provided without charge to the owner. Such use will not reduce the warranty obligations of Yamaha Golf-Car Company.
10. Add-on or modified parts that are not exempted by the Air Resources Board may not be used. The use of any non-exempted add-on or modified parts by the ultimate purchaser will be grounds for disallowing a warranty claims. Yamaha Golf-Car Company will not be liable to warrant failures of warranted parts caused by the use of a non-exempted add-on or modified part.

WARRANTED PARTS:

The repair or replacement of any warranted part otherwise eligible for warranty coverage may be excluded from such warranty coverage if Yamaha Golf-Car Company demonstrates that the SORE vehicle has been abused, neglected, or improperly maintained, and that such abuse, neglect, or improper maintenance was the direct cause of the need for repair or replacement of the part. That notwithstanding, any adjustment of a component that has a factory installed, and properly operating, adjustment limiting device is still eligible for warranty coverage. The following emission warranty parts are covered:

1. Fuel Tank
2. Fuel Cap
3. Fuel Line
4. Fuel Line Fittings
5. Clamps
6. Control Valves
7. Control Solenoids
8. Electronic Controls
9. Control Cables
10. Control Linkages
11. Vapor Hoses
12. Carbon Cannister
13. Cannister Mounting Brackets

IMPORTANT LABELS

⚠ SAFETY AND INSTRUCTION LABELS

⚠ WARNING

Read the following labels carefully before operating your golf car, and promptly replace any labels which become damaged or removed. Death or serious personal injury can result from failing to read and comply with the safety labels in this manual.

2

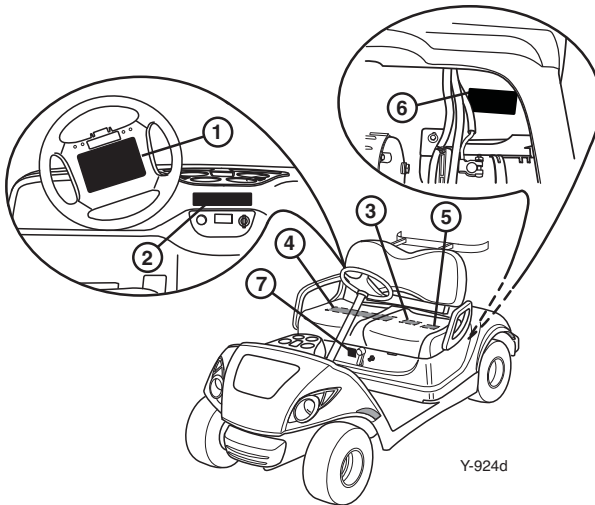

①

OPERATING INSTRUCTIONS

- Read the warning label on the beverage holder panel before operating.
- Be sure occupants are seated.
- Select "FORWARD" or "REVERSE" then turn main switch to "ON".
- Press the accelerator pedal to start moving. The motor will start and the parking brake will release automatically.
- To stop, release the accelerator pedal and press the brake pedal.
- Never travel at speeds too fast for the terrain, visibility conditions, or your experience.
- Drive with extra caution in congested areas, when operating in reverse, and when driving on wet, rough, or loose surfaces.
- Come to a complete stop before reversing direction.
- Press the parking brake pedal until it locks, and turn the main switch to "OFF" before leaving the vehicle.
- Read the Owner's/Operator's Manual for more information.

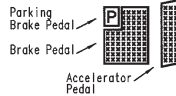

ATTENTION

- This vehicle was not manufactured for use on public streets and does not comply with federal motor vehicle safety standards applicable to passenger cars.

YAMAHA

JUO-K7762-00

IMPORTANT LABELS

③

⚠ WARNING

DEATH OR SEVERE PERSONAL INJURY CAN RESULT FROM FAILURE TO FOLLOW THESE INSTRUCTIONS.

- Read the label located on the steering wheel before operation.
- Operate only when authorized and only in designated areas.
- Operate from driver's side only.
- Do not allow more than two occupants per seat.
- Do not start vehicle until all occupants are seated.
- Remain seated and hold on when in motion.
- Keep entire body inside vehicle.
- Drive slowly in turns.

OIL WARNING

YAMAHA

OFF
▶

ON
▶

JMW1-K7768-00

③

This spark ignition system meets all requirements of the Canadian Interference Causing Equipment Regulations.
Ce système d'allumage par étincelle de véhicule respecte toutes les exigences du Règlement sur le matériel brouilleur du Canada.

YAMAHA

JNB-H2377-50

Y-1606

④

⚠ WARNING

GASOLINE IS HIGHLY FLAMMABLE AND EXPLOSIVE. A fire or explosion could cause SEVERE INJURY or DEATH.

- Keep heat, sparks, and open flame away from fuel tank and fuel lines.
- Do not add fuel while engine is running or hot.
- Do not modify fuel system.
- Services should be performed by dealer or qualified personnel.

YAMAHA

⚠ AVERTISSEMENT

L'UTILISATION A DES VITESSES SUPERIEURES PEUT ENTRAINER UNE PERTE DE CONTROLE QUI PEUT PROVOQUER DE GRAVES BLESSURES OU LA MORT.

- Ne pas aller à la régulateur pour augmenter la vitesse.

JMW-K6297-01

N432



Y-1669a



IMPORTANT LABELS

⑤

YEAR OF CONSTRUCTION: 20XX	MODEL: YDRAX
YAMAHA MOTOR POWERED PRODUCTS CO., LTD.	MAX. POWER: X.X KW
200-1 SAKAGAWA, KAKEGAWA, JAPAN	DRY WEIGHT: XXX kg
MAX. BATTERY WEIGHT: XX kg	JXX-F4236-XX

Y-1607c

2

⑥

EMISSION CONTROL INFORMATION
YAMAHA MOTOR CO.,LTD.



THIS EQUIPMENT CONFORMS TO 20XX CALIFORNIA EVPI/EH EMISSION REGULATIONS AND MEETS U.S. EPA EVAP STANDARDS FOR SMALL OFF-ROAD ENGINES. THIS ENGINE CONFORMS TO PHASE 3 U.S. EPA REGULATIONS FOR SMALL OFF-ROAD ENGINES.

EFT:BYMKS.3572EB	DISPLACEMENT : 357cc
DOM :	EMISSION CONTROL SYSTEM : EM
THIS ENGINE IS CERTIFIED TO OPERATE ON UNLEADED GASOLINE	EVAPORATIVE CODE CARB : CCYMD33C
MAINTENANCE SPECIFICATIONS	EVAPORATIVE CODE EPA:BYMDXPNHEQ33C
IGNITION TIMING : 27 BTDC	ENGINE OIL : SAE 10W-30
NO OTHER ADJUSTMENTS NEEDED	SPARK PLUG GAP : .028-.031

The air index of this engine is 3

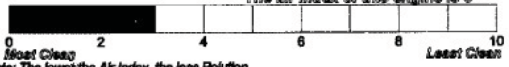

Note: The lower the Air Index, the less Pollution
This engine is certified to be emissions compliant for the following use:
[] Moderate (125 hours) [] Intermediate (250 hours) [X] Extended (1000 hours)
Check owner's manual for further details. JW8-F179T-01

Y-1599c

⑦

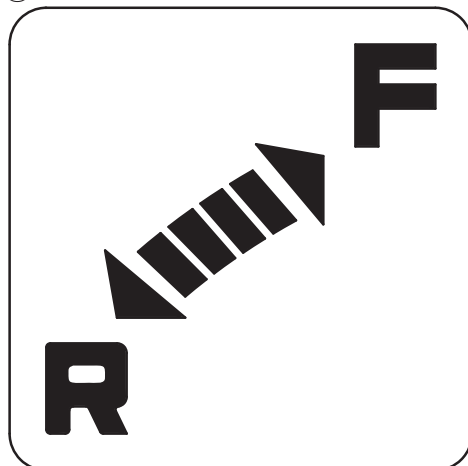

Y-1610

IMPORTANT LABELS

2

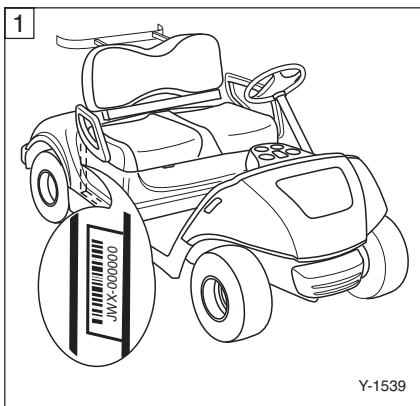

GOLF CAR SERIAL NUMBER

The golf car serial number ① is identified in the location shown.

TIP

The first three digits of the serial number are for model identification; the remaining digits are the unit production number. Keep a record of these numbers for reference when ordering parts from a Yamaha Golf-Car Company dealer.

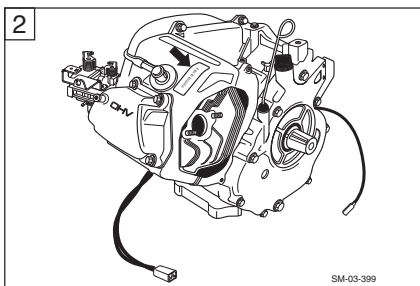

The engine serial number ② is affixed in the location shown.

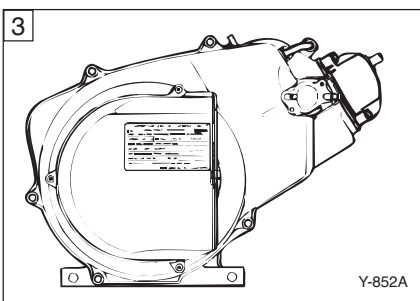

③ Engine Information

IMPORTANT ENGINE INFORMATION				YAMAHA
ENGINE FAMILY : *****				
E M REFER TO OWNER'S MANUAL FOR MAINTENANCE SPECIFICATIONS AND ADJUSTMENTS.				
DISPLACEMENT:	*** cc ³	VALVE L4(SIDE)	V *****	EX: **,**
IGNITION TIMING & EXE MIXTURE		NO OTHER ADJUSTMENTS NEEDED.		
IDLE SPEED:	**** rpm	AT NO LOAD		
FUEL: THIS ENGINE IS CERTIFIED TO OPERATE ON UNLEADED GASOLINE.				
ENGINE OIL:	SAE 10W-30	TYPE	SD	
<small>THIS ENGINE MEETS ***** CALIFORNIA EMISSION REGULATIONS FOR OFF-ROAD ENGINES. THIS ENGINE CONFORMS TO ***** U.S. EPA REGULATIONS FOR SMALL HOURLY/ROAD ENGINES.</small>				
YAMAHA MOTOR CO., LTD.				

Y-851a



OPERATOR SAFETY

Yamaha golf cars are designed to be simple to operate. However, be sure to observe the following to reduce the risk of serious injury or death due to loss of control and other hazards:

BEFORE OPERATING THE GOLF CAR

- Read this Owner's/Operator's manual and all safety and instruction labels on the golf car before operating.
- Perform the pre-operation checks found in Section 6 of this manual.
- Only authorized people should drive the golf car, from the driver's side only, and only in designated areas.
- Do not allow more than two occupants per seat. This golf car is restricted to two occupants unless equipped with a rear seat.
- Do not operate the golf car while under the influence of alcohol or drugs; their effect on vision and judgment make operating a golf car dangerous.
- Do not operate the golf car on public streets, roads or highways unless allowed by law or the local regulating authority.

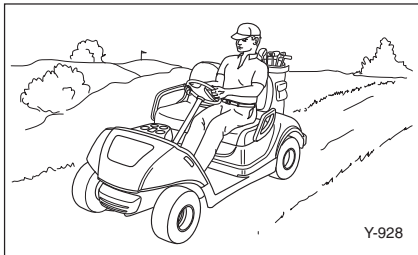

WHILE OPERATING THE GOLF CAR

- Keep your entire body inside the golf car, remain seated and hold on when the car is in motion.
- Do not start the golf car until all occupants are seated.
- Keep your hands on the steering wheel and your eyes on the path ahead.



OPERATOR SAFETY

3



- Use extra care in congested areas or when backing up. Always back up slowly, and watch carefully.
- Avoid starting or stopping abruptly.
- Vary the speed of the golf car to match the terrain of the course.
- Avoid turning the steering wheel too sharply at higher speeds to avoid tipping or rolling the golf car.
- Always drive slowly straight up or straight down slopes – never at an angle to avoid tipping or rolling the golf car.

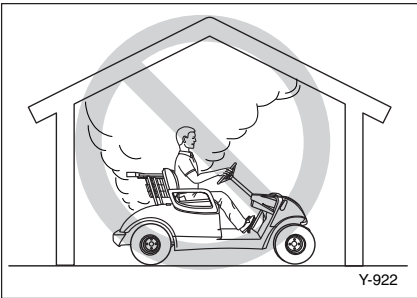

- Do not run the engine indoors. Exhaust gas is poisonous and could result in carbon monoxide poisoning.

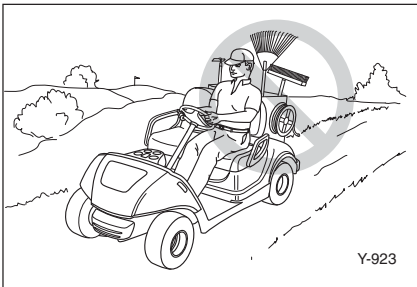

- Do not make any modification or addition which affects capacity or safe operation, or make any changes not in accordance with the owner's/operator's manual.



SAFETY CONSIDERATIONS

Like all machines, golf cars can cause injury if improperly used or maintained. This section contains broad safety practices required for safe golf car operation. Before golf cars are operated, golf course personnel should establish any additional safety practices that may be required for safe operation.

Experience has shown that golf cars are safe when operated in accordance with the safety warnings affixed to every golf car. This safe operation is enhanced when golf cars are used according to the safety rules and practices established to meet the terrain and conditions of the course they are used on.

The information contained here is intended for golf course personnel responsible for golf car safety. If you are responsible for the operation and maintenance of this golf car, we encourage you to implement this golf car safety program.

DRIVER QUALIFICATIONS

Allow only authorized people to operate golf cars. It is recommended that only people who possess a valid motor vehicle driver's license be allowed to operate golf cars.

Place operation and safety instructions recommended by the golf car manufacturer, along with the golf course safety rules, in a conspicuous place near the golf car rental area or golf car pick-up area. It is also recommended that the following warning be posted in a conspicuous location:

WARNING

Do not operate golf cars or utility vehicles when under the influence of alcohol or drugs. Death or serious personal injury can result from failing to comply with the safety and warning instructions affixed to the golf car or utility vehicle.

GOLF COURSE SAFETY SURVEY

Perform safety surveys regularly to identify hazardous areas where golf cars should not be operated.

GOLF COURSE HAZARD PREVENTION

The following golf course hazards must be made safe:

- **Steep Grades.** Where steep grades exist, restrict golf cars to designated golf car pathways where possible. In addition, identify steep grades with a suitable warning like:

WARNING

Descend steep grades slowly with foot on brake. Death or serious personal injury can result from failing to comply with the safety and warning instructions affixed to the golf car or utility vehicle.

- **Sharp Turns, Blind Corners, Bridge Approaches.** Chain or rope off these potentially hazardous areas or identify them with a suitable warning describing the nature of the hazard and the proper precautions to be taken to avoid the hazard.



SAFETY CONSIDERATIONS

4

- **Wet Areas.** Wet grass may cause a golf car to lose traction and may affect stability. Golf car operators should reduce speed in wet areas or during periods of inclement weather.
- **Loose Terrain.** Loose terrain may cause a golf car to lose traction and may affect stability. Repair loose terrain, chain or rope off these areas, or identify loose terrain with a suitable warning.
- **Golf Car and Pedestrian Interference.** Reroute golf car traffic or pedestrian traffic in congested areas wherever possible to prevent accidents. If it is impractical to reroute traffic, erect warning signs to warn pedestrians of golf car traffic, and to warn golf car operators to drive slowly, use caution and watch for pedestrians.
- **Personnel.** Allow only qualified, trained, and authorized personnel to inspect, adjust and maintain golf cars.
- **Parts and Materials.** Use only replacement parts and materials recommended by the manufacturer.
- **Ventilation.** Properly ventilate all maintenance and storage areas in accordance with applicable fire codes and ordinances to avoid fire hazards. Ventilation is required to remove flammable vapors and fumes from gasoline powered car storage areas. Ventilation is also required to remove hydrogen gas from the car storage areas during the battery charging process.

MAINTENANCE REQUIRED FOR GOLF CAR SAFETY

Practice the following to help ensure the safety of golf car operators:

- **Preventative Maintenance.** Perform all scheduled maintenance in accordance with manufacturer's recommendations to provide the golfing patron with a safe, properly operating golf car.



SAFETY CONSIDERATIONS

SAFETY PRECAUTIONS DURING MAINTENANCE

When performing maintenance, follow all safety instructions contained in the manufacturer's operation and service manuals, as well as the following safety procedures:

- Properly immobilize golf car before beginning any maintenance to avoid any unexpected vehicle movement.
- Properly block chassis before working underneath golf car to avoid any unexpected vehicle movement.
- Before disconnecting any part of the fuel system, drain the applicable part of the system to prevent fuel leaks.
- When working on the fuel system or the battery, do not smoke, or allow any sparks or open flames near the vehicle, to avoid any fires or explosions.
- Before performing any maintenance, disable the car's electrical system in accordance with the manufacturer's instructions.
- Use only properly insulated tools when working around batteries to avoid electrical shock or damage to the electrical system.
- Maintain all safety devices, including brakes, steering mechanisms, warning devices and governors, in a safe operating condition. Do not modify these safety devices as supplied by the manufacturer.
- After each maintenance or repair, the car must be driven by a qualified, trained and authorized person – in an area free of pedestrian traffic – to ensure proper operation and adjustment.

- Record all maintenance performed in a maintenance record log by date, name of person performing maintenance and type of maintenance. Periodically inspect maintenance log to ensure accurate and complete entries.
- Provide operator comment cards to assist in identifying non-periodic maintenance needs for specific golf cars.
- Maintain in a legible condition all nameplates, warnings, and instructions provided by the manufacturer.
- If new nameplates, warnings or instructions are needed, contact your Yamaha Golf-Car Company dealer.

FUEL HANDLING/ STORAGE AND BATTERY CHARGING

Take the following precautions to ensure maintenance worker safety:

- Supervise the storage and handling of liquid fuels in accordance with applicable fire and safety requirements to avoid any fires or explosions.
- Only use battery charging facilities and procedures that are in accordance with applicable ordinances and regulations to avoid explosions, electrical shock or damage to the electrical system.
- Periodically inspect fueling to be certain that applicable safety codes, regulations and procedures are being followed to avoid any fires or explosions.

CONTROLS

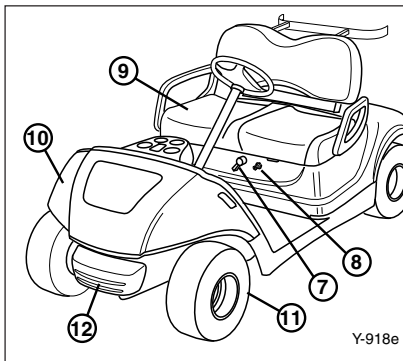
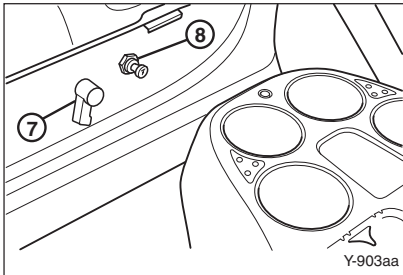
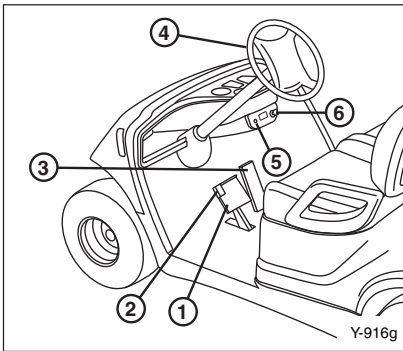

FEATURES

- ① Brake pedal
- ② Parking brake pedal
- ③ Accelerator pedal
- ④ Steering wheel
- ⑤ Oil warning light
- ⑥ Main switch
- ⑦ Drive select lever
- ⑧ Choke knob
- ⑨ Seat
- ⑩ Front body
- ⑪ Front tire
- ⑫ Front bumper
- ⑬ Battery
- ⑭ Rear body
- ⑮ Rear tire
- ⑯ Rear bumper
- ⑰ Fuel tank
- ⑱ Fuel cap
- ⑲ Fuel shutoff valve
- ⑳ Fuel tank vent (California models only)

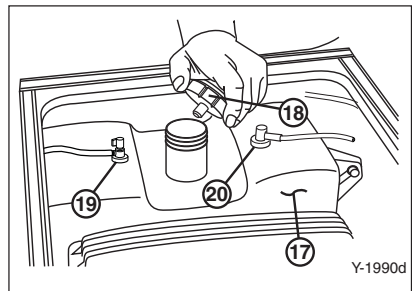
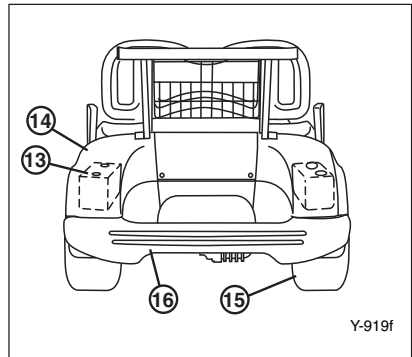

CONTROLS

MAIN SWITCH

The main switch controls the following items:

“OFF”

All electrical circuits are switched off. The key can be removed only in this position.

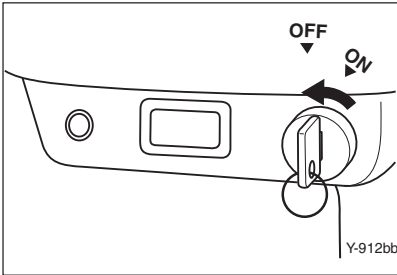

“ON”

Electrical circuits are switched on. The golf car can be driven.

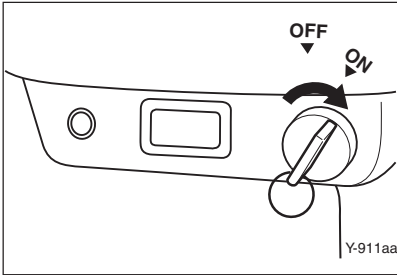

OIL WARNING LIGHT

When the engine oil level falls below an acceptable level, this light comes on.

NOTICE

If the light comes on, stop the engine, check the engine oil level and add oil as necessary. Engine damage can result from low engine oil levels. (See page 6-3).

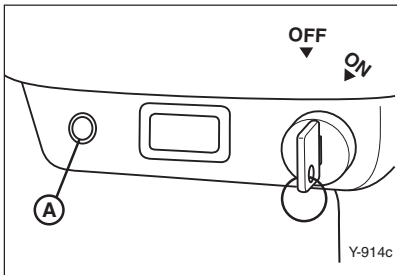

Ⓐ Oil warning light

CONTROLS

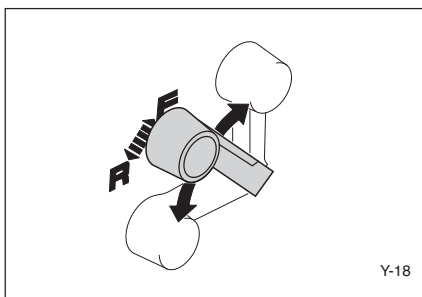

DRIVE SELECT LEVER

The drive select lever is used to shift the golf car into forward or reverse. After coming to a complete stop, move the lever to the desired position.

Lever Position	Car Movement
F	FORWARD
R	REVERSE

5

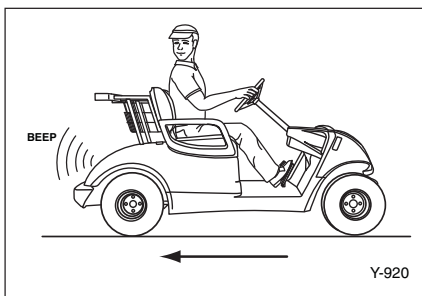

TIP

The reverse alarm will sound when the drive select lever is turned to "R."

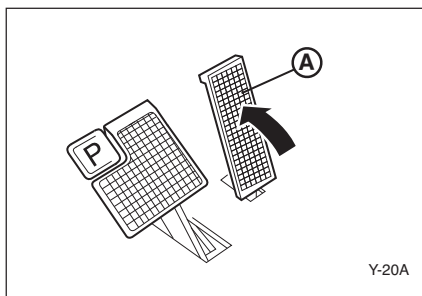

ACCELERATOR PEDAL

The accelerator pedal controls the golf car's speed.

Action	Car Speed
Depress pedal	Increase
Release pedal	Decrease

Ⓐ Accelerator pedal

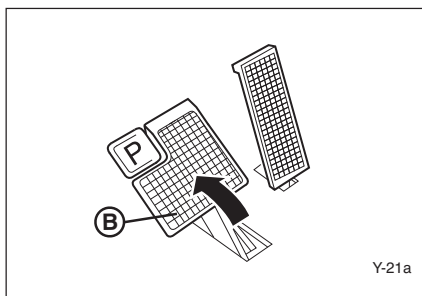

BRAKE PEDAL

Press down on the brake pedal to stop the golf car.

Ⓑ Brake pedal

CONTROLS

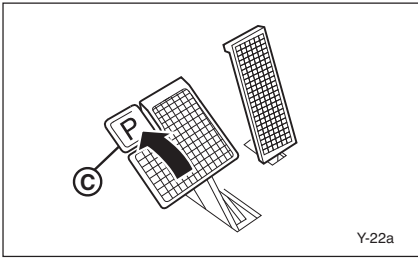

PARKING BRAKE PEDAL

Press down on the parking brake pedal whenever parking the golf car.

© Parking brake pedal

TIP

Release the parking brake by depressing the accelerator pedal.

⚠ WARNING

The parking brake will automatically release when the accelerator pedal is depressed. If the main switch is in the "ON" position, depressing the accelerator may suddenly cause the golf car to move. Death or serious personal injury can result from failing to comply with the safety instructions in this manual.

5

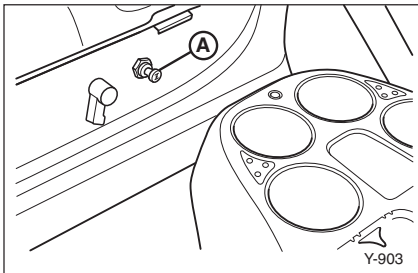

CHOKE KNOB

Pull and hold out choke knob when starting a cold engine. Release the knob after the engine starts.

Ⓐ Choke knob

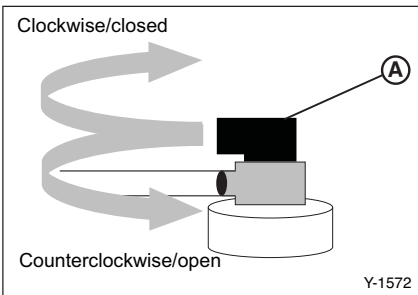

FUEL SHUTOFF VALVE

Ensure the fuel shutoff valve is in the "OPEN" position for normal operation.

Ⓐ Fuel shutoff valve

PRE-OPERATION CHECKS

Pre-operation checks should be made each time you use your golf car. Get in the habit of performing the following checks in the same way so that they become second nature.

⚠ WARNING

To keep car from moving while performing pre-operation checks:

- Remove main switch key.
- Apply parking brake.

Death or serious personal injury can result from failing to comply with the safety instructions in this manual.

6

PRE-OPERATION CHECKLIST

Before each use check the following:

- ✓ Fuel system
- ✓ Engine oil level
- ✓ Battery
- ✓ Tire condition
- ✓ Steering system
- ✓ Reverse alarm
- ✓ Pedal operation
- ✓ Body and chassis

SEAT

Open the seat for checking and servicing.

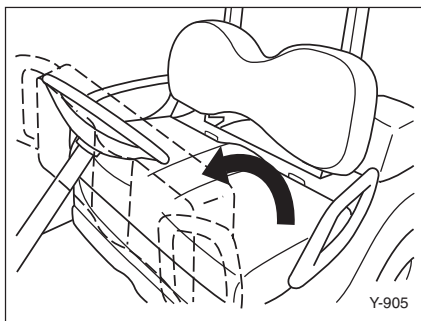

PRE-OPERATION CHECKS

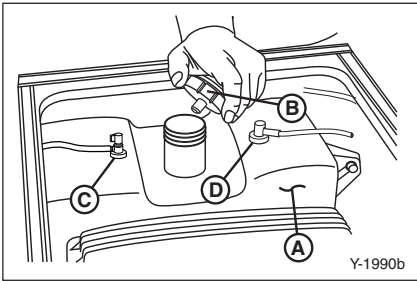

FUEL SYSTEM

Make sure there is sufficient fuel in the tank and that the fuel shutoff valve is open. Also check fuel line and connections for leakage.

- (A) Fuel tank
- (B) Fuel cap
- (C) Fuel shutoff valve
- (D) Fuel tank vent

⚠ WARNING

Gasoline and its vapors are highly flammable and explosive. To avoid fires and explosions and to reduce the risk of injury when refueling, follow these instructions.

1. Stop engine and allow it to cool for several minutes before refueling.
Do not smoke when refueling and keep away from sparks, flames or other sources of ignition.
Refuel in a well-ventilated area.
2. Take care not to spill gasoline. If gasoline spills, wipe it up immediately with dry rags. Always dispose of gasoline-soaked rags properly.
3. Tighten the filler cap securely after refueling.

⚠ WARNING

Gasoline is poisonous and can cause injury or death. If you swallow gasoline, inhale a lot of gasoline vapor or get gasoline in your eyes, get immediate medical attention.

If any gasoline gets on your skin, immediately wash with soap and water. Change clothing if gasoline spills on it.

Recommended fuel:
Unleaded gasoline

Fuel tank capacity:
22.0 L (5.8 US gal)

Gasoline-based fuels containing more than 10% ethanol are not recommended and may void the warranty.

PRE-OPERATION CHECKS

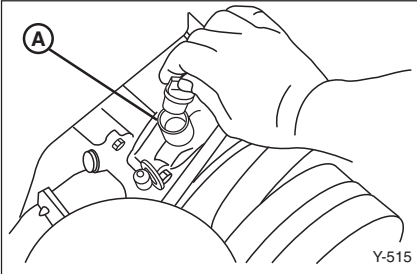
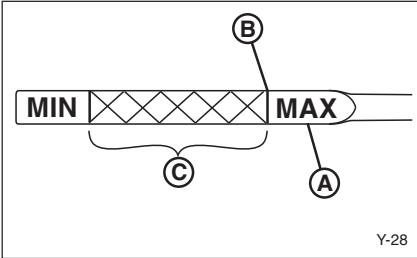
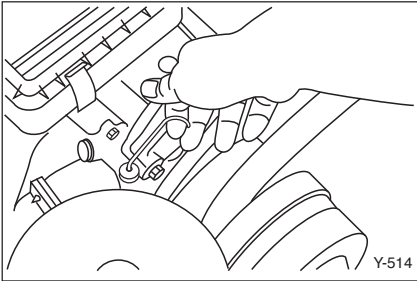

Recommended oil:
YAMALUBE 4-cycle oil or 10W30

Engine oil capacity:
1.0 L, 1000 cc
(1.0 US qt)

Oil change quantity:
1.0 L, 1000 cc
(1.0 US qt)

NOTICE

Avoid using gasoline blended with methyl alcohol which can damage fuel system parts.

ENGINE OIL

With the golf car parked on level ground, remove the dipstick and make sure the engine oil is between the MIN and MAX marks (the crosshatched area on the end of the dipstick).

- Ⓐ Oil level dipstick
- Ⓑ Maximum oil level
- Ⓒ Safe operating range

If the oil level is **below** the MIN mark on the dipstick, add oil through the oil filler hole until the oil level is between the MIN and MAX marks.

- Ⓐ Oil filler hole

NOTICE

Engine damage can result.

- Use care not to fill past the MAX dipstick mark, and be sure no foreign material enters the crankcase.
- Use care not to get oil on the starter belt.

TIP

The distance between the dipstick marks represents approx. 1/2 L (1/2 US qt) of oil.

TIP

Recommended engine oil classification: API Service SE, SF, or SG. Engine oils labeled "Energy Conserving II" are recommended.

PRE-OPERATION CHECKS

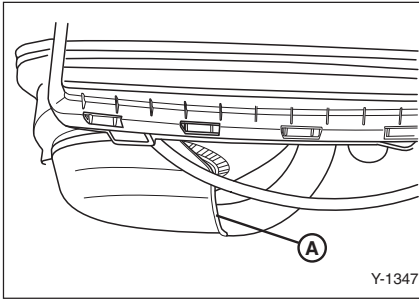

Engine Cooling Inlet Duct

Check the engine cooling inlet duct for debris. Remove any debris present.

- Ⓐ Engine cooling inlet duct

BATTERY

Check that the battery is held securely in place to prevent the battery from being damaged from vibration or jarring. Also check that no battery caps are missing to prevent battery acid from spilling from the battery. Check the battery terminals for corrosion.

⚠ WARNING

Battery electrolyte is poisonous and dangerous, causing severe burns, etc. It contains sulfuric acid. Avoid contact with skin, eyes or clothing. Ventilate when charging or using in enclosed space. Always shield eyes when working near batteries. KEEP OUT OF REACH OF CHILDREN.

6

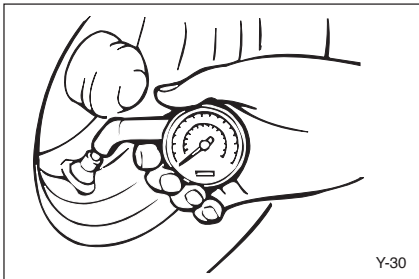

TIRE CONDITION

Tire Air Pressure

Check the tire air pressure before operating the golf car.

Tire pressure:

110 kPa, 1.1 kgf/cm² (16 psi)

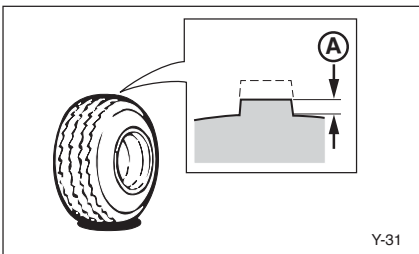

Tire Wear Limit

Check the tire surface for damage, cracks or embedded objects. When tire tread wears down to 1 mm (0.04 in.), replace the tire.

- Ⓐ Wear limit

PRE-OPERATION CHECKS

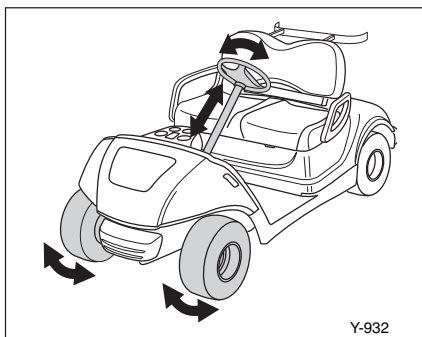

STEERING SYSTEM

Check the steering system for excessive free play by:

- moving the steering wheel up and down, and back and forth.
- turning the steering wheel slightly to the right and left.

If you feel excessive free play, or hear rattling sounds which may indicate loose steering components, consult a Yamaha dealer.

6

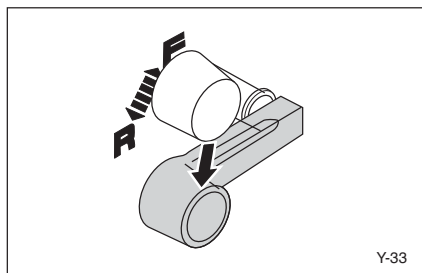

REVERSE ALARM

Check the reverse alarm by moving the drive select lever to “R” for reverse. The alarm should sound.

PEDAL OPERATION

Check the following pedal controls for proper operation. If a pedal does not work properly, consult a Yamaha dealer.

Accelerator Pedal

⚠ WARNING

Make sure the main switch is in the “OFF” position.

Make sure the accelerator pedal operates smoothly.

Ⓐ Accelerator pedal

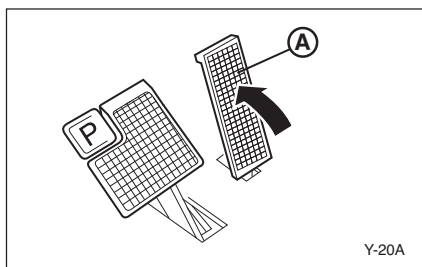

PRE-OPERATION CHECKS

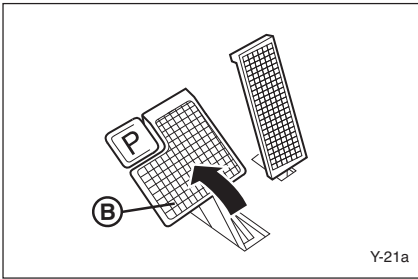

Brake Pedal

Make sure the brake pedal feels firm when pressed and returns to its original position when released.

- Ⓑ Brake pedal

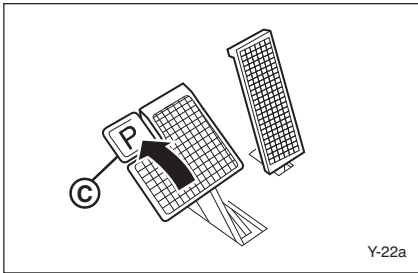

Parking Brake Pedal

Make sure the parking brake pedal locks in place with a positive click, and releases when the accelerator pedal is pressed.

- Ⓒ Parking brake pedal

TIP

Release the parking brake by depressing the accelerator pedal.

6

BODY AND CHASSIS

Before each use, visually inspect the golf car body and chassis for damage and/or missing parts.

OPERATION

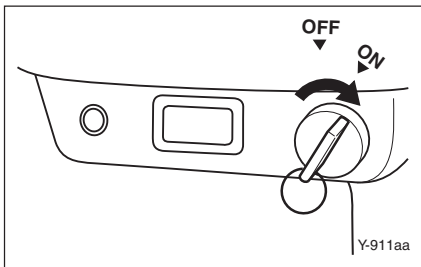
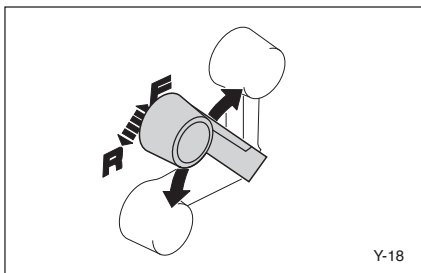

7

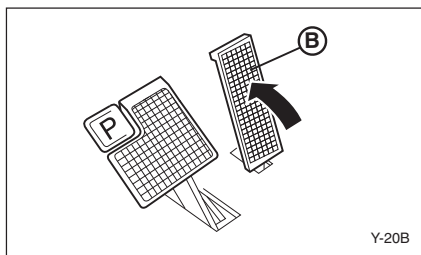
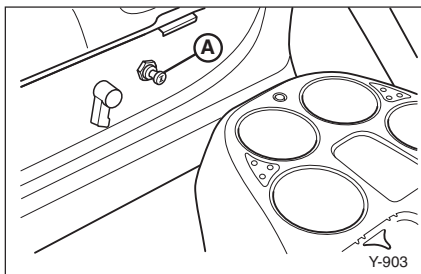

STARTING

1. With the parking brake applied, turn the drive select lever to “F” for forward, or “R” for reverse.

NOTICE

Do not shift from “F” forward to “R” reverse while the golf car is moving. Transmission damage can result.

2. Turn the main switch to “ON.”

⚠ WARNING

Do not depress the accelerator pedal when turning on the main switch or the golf car may start moving unexpectedly. Death or serious personal injury can result from failing to comply with the safety instructions in this manual.

3. Pull the choke knob out and hold it while starting. Release the choke knob after the engine starts.

Ⓐ Choke knob

TIP

The choke is not required when the engine is warm.

4. Check that your path is clear in the direction you plan to go, and slowly depress the accelerator pedal. The golf car will start to move.

Ⓑ Accelerator pedal

TIP

The parking brake automatically releases when the accelerator pedal is depressed.

OPERATION

STOPPING

To stop the golf car, gradually press down on the brake pedal.

- Ⓐ Brake pedal

When the car has come to a stop, apply the parking brake pedal and turn the main switch to "OFF."

- Ⓑ Parking brake pedal

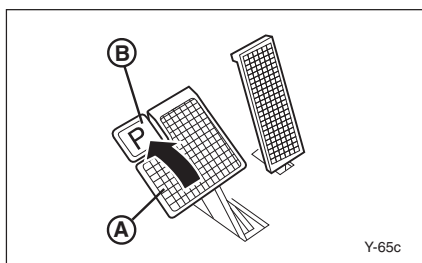

NOTICE

Do not hold the golf car on an incline with the accelerator – use the brake. Transmission damage can result.

MAINTENANCE

PERIODIC MAINTENANCE CHARTS

Regular maintenance is required for the best performance and safe operation of your golf car.

⚠ WARNING

Be sure to turn off the main switch and apply the parking brake when you perform maintenance, unless otherwise specified. If the owner is not familiar with servicing the machine, death or serious personal injury can result. When in doubt the work should be done by a Yamaha dealer or other qualified mechanic.

CS - CHECK CA - CHECK AND ADJUST R - REPLACE S - SERVICE CL - CLEAN AND LUBRICATE L - LUBRICATE

	Remarks	Daily Pre-Operation	40 Rounds 20 hours 100 miles 160 kms (Every month)	250 rds 125 hrs 600 mls 1000 kms (Every 6 months)	500 rds 250 hrs 1200 mls 2000 kms (Every year)	1000 rds 500 hrs 2500 mls 4000 kms (Every 2 years)	2000 rds 1000 hrs 5000mls 8000 kms (Every 4 years)	Page
PRE-OP	Check engine oil	CS	CS	CS				6-3
	Check air cooling duct	CS	CS	CS	CS	CS	CS	*
	Check fuel lines for leakage	CS	CS	CS	CS	CS	CS	6-2
	Check fuel level	CS	CS	CS	CS	CS	CS	6-2
	Check for looseness and corrosion of battery terminals and hold downs	CS	CS	CS	CS	CS	CS	6-4
	Check brake pedal free play and adjust if necessary	CS	CA	CA	CA	CA	CA	8-13
	Check steering operation	CS	CS	CS	CS	CS		6-5
	Check tire pressure, tread depth, tire surface for damage	CS	CA	CA	CA	CA	CA	6-4
	Check body and chassis for damage	CS	CS	CS	CS	CS	CS	6-6
	Check tightness of all bolts, nuts, screws and rivets	CS	CS	CS	CS	CS	CS	*
Check reverse alarm operation	CS	CS	CS	CS	CS	CS	6-5	
EVERY MONTH	Check fuel filter for clogging		CS	CS	CS	CS	CS	*
	Check wear of drive belt		CS	CS	CS	CS	CS	8-7/ 8-8
	Check operation of Forward / Reverse shifting		CS	CS	CS	CS	CS	7-1
	Clean / Lube pedal control area		CL					*
EVERY 6 MONTHS	Wash pre-filter, check air cleaner element			S	S	S	S	8-6/ 8-7
	Check spark plug and plug cap condition** / Check compression			CS	CS	CS	CS	8-4
	Check shock absorbers for oil leaks and damaged springs			CS	CS	CS		*

* Items without a page number reference should be serviced by a Yamaha dealer or other qualified mechanic. This manual does not contain these procedures. They are contained in the Service Manual.

** Related to emission control system.

MAINTENANCE

CS - CHECK **CA** - CHECK AND ADJUST **R** - REPLACE **S** - SERVICE **CL** - CLEAN AND LUBRICATE **L** - LUBRICATE

	Remarks	Daily Pre-Operation	40 Rounds 20 hours 100 miles 160 kms (Every month)	250 rds 125 hrs 600 mls 1000 kms (Every 6 months)	500 rds 250 hrs 1200 mls 2000 kms (Every year)	1000 rds 500 hrs 2500 mls 4000 kms (Every 2 years)	2000 rds 1000 hrs 5000mls 8000 kms (Every 4 years)	Page
EVERY YEAR	Replace engine oil				R	R	R	8-5
	Adjust throttle cables,** choke cable, check carburetor throttle shaft for wear**				CA	CA	CA	*
	Check starter V-belt for damage and tension				CS	CS	CS	*
	Check drive belt for slippage, wear or scratches				CS	CS	CS	8-7
	Check operation of speed limiter				CS	CS	CS	*
	Apply battery terminal protectant				S	S	S	*
	Check wiring connections and insulation				CS	CS	CS	*
	Check rear axle bearing play for roughness or freeplay				CS	CS	CS	*
	Check steering knuckle bushing free play / Adjust wheel alignment				CA	CA	CA	*
	Check wheel nut tightness, front wheel bearing play				CS	CS	CS	*
	Check transaxle oil level and inspect for leakage				CS	CS	CS	8-10
EVERY 2 YEARS	Check brushes for wear and commutator for dirt					CS	S	*
	Replace transaxle oil					R		*
EVERY 4 YEARS	Replace fuel filter and fuel hoses						R	*
	Check tightness of cylinder head / Adjust valves						CA	*
	Inspect internal wet brake and replace pads if necessary						CS R	*

* Items without a page number reference should be serviced by a Yamaha dealer or other qualified mechanic. This manual does not contain these procedures. They are contained in the Service Manual.

** Related to emission control system.

MAINTENANCE

EXHAUST EMISSION CONTROL SYSTEM AND COMPONENTS

Item	Abbreviation
<ul style="list-style-type: none"> CARB. ASSY., LH., JT., CARBURETOR 2 & JT., CARBURETOR 1 	CARB (Carburetor)
<ul style="list-style-type: none"> T.C.I. MAGNETO ASSY. & PLUG, SPARK 	EI (Electronic Ignition)
<ul style="list-style-type: none"> CRANKCASE 1 & HEAD, CYLINDER 1 	PCV (Positive Crankcase Ventilation)
<ul style="list-style-type: none"> AIR FILTER ASSY. 	ACL (Air Cleaner)
<ul style="list-style-type: none"> MUFF. ASSY., 1 	MUFF., 2
<ul style="list-style-type: none"> CARBON CANISTER 	CC
<ul style="list-style-type: none"> INVERSION VALVE 	IV

The above items and the corresponding abbreviations are provided in accordance with U.S. EPA REGULATIONS FOR SMALL NONROAD ENGINES and the CALIFORNIA REGULATIONS FOR NEW 1995 AND LATER OFF-HIGHWAY RECREATIONAL VEHICLES AND ENGINES.

The abbreviations conform to the latest version of the SAE's recommended practice document J1930, "Diagnostic Acronyms, Terms, and Definitions For Electrical/Electronic System".

It is recommended that these items be serviced by a Yamaha dealer or other qualified mechanic.

TROUBLESHOOTING

If the vehicle's engine won't start, use the following chart:

Cause	Remedy
Fuel System	
No fuel in tank	Fill fuel tank
Fuel shutoff valve closed	Open fuel shutoff valve
Clogged fuel line	Clean fuel line – Consult Yamaha dealer
Foreign matter in fuel filter	Clean fuel filter – Consult Yamaha dealer
Clogged carburetor	Clean carburetor – Consult Yamaha dealer
Electrical System	
Spark plug dirty with carbon, or wet	Clean carbon or wipe spark plug dry
Faulty ignition system	Consult Yamaha dealer

MAINTENANCE

Spark Plug Inspection

You should periodically remove and inspect the spark plug. Dirty or worn spark plugs can cause poor performance.

⚠ WARNING

When removing or installing the spark plug, be careful not to damage the insulator. A damaged insulator could allow external sparks, which could lead to explosion or fire. Death or serious personal injury can result from failing to comply with the safety instructions in this manual.

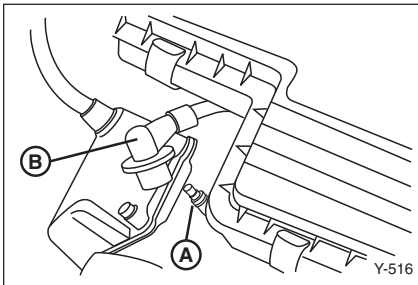

- (A) Spark plug
- (B) Spark plug cap

1. Check for discoloration and remove carbon deposits with a spark plug cleaner or wire brush. The normal electrode color will be tan.
2. Check the spark plug type, and check the spark plug gap with a feeler gauge.

Standard spark plug:
BPR2ES

Spark plug gap:
0.7 ~ 0.8 mm (0.028 ~ 0.031 in.)

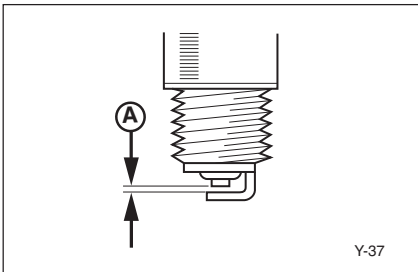

- (A) Gap
3. Clean the gasket and plug surfaces and install the spark plug finger-tight before tightening to the following torque:

Spark plug torque:
20 Nm, 2.0 m·kg
(14.5 ft·lb)

MAINTENANCE

Engine Oil Replacement

1. Warm up the engine for several minutes, place the golf car on a level surface, then stop the engine.

WARNING

Use caution not to touch hot engine oil or hot engine parts, during the following procedure. Death or serious personal injury can result from failing to comply with the safety instructions in this manual.

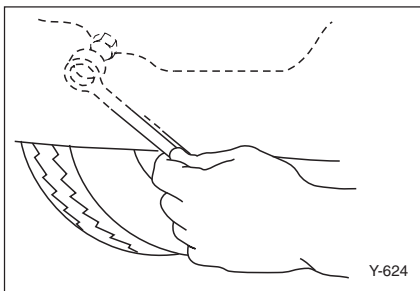

8

Recommended oil:
YAMALUBE 4-cycle oil or 10W30

Engine oil capacity:
1.0 L, 1000 cc
(1.0 US qt)

Oil change quantity:
1.0 L, 1000 cc
(1.0 US qt)

2. Place an oil pan under the engine drain plug.
3. Remove the oil drain plug and let the oil drain completely.

TIP

Dispose of used oil in an environmentally safe way, such as taking oil to an oil collection station.

4. Install the drain plug, along with a new drain plug gasket, finger-tight before tightening to the following torque:

Drain plug torque:
31 Nm, 3.1 m·kg
(23 ft·lb)

5. Add the correct quantity of oil through the oil filler hole.

TIP

Recommended engine oil classification: API Service SE, SF, or SG. Engine oils labeled "Energy Conserving II" are recommended.

MAINTENANCE

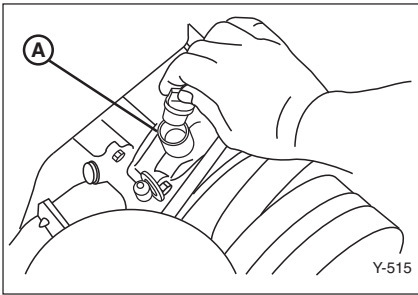

(A) Oil filler hole

NOTICE

Use care not to fill past the MAX dipstick mark, and be sure no foreign material enters the crankcase. Serious engine damage can result.

After replacing engine oil, check for oil leaks around the drain plug. If oil leaks are found, consult a Yamaha dealer.

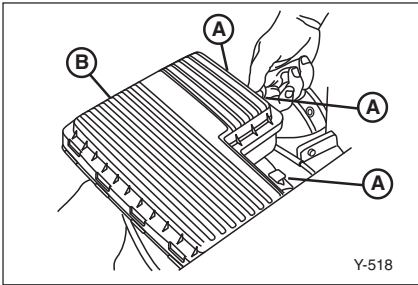

Air Filter

To remove the air filter elements:

1. Unlatch the air filter cover clips and remove cover.

(A) Air filter cover clips
(B) Air filter cover

2. Lift the air filter and pre-filter out of the air filter case.

(C) Air filter
(D) Pre-filter

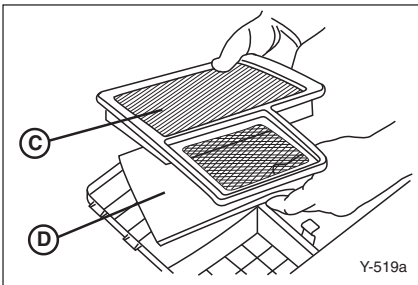

NOTICE

Be careful not to drop anything into the air inlet. Serious engine damage can result.

MAINTENANCE

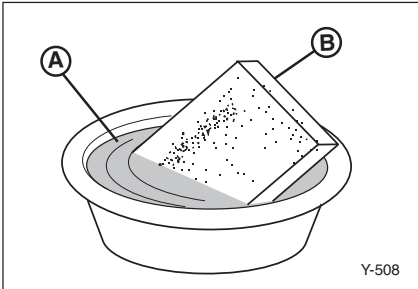

Inspection and cleaning:

3. Wash the foam pre-filter in soap and water. Allow it to dry.

- (A) Soap and water
- (B) Foam element

4. Check the filter element. If damaged or dirty, replace it.

NOTICE

Do not wring out the foam pre-filter, this could cause it to tear.

5. To replace the elements, reverse the above steps.

NOTICE

The pre-filter has a notch on one side. It will only fit in the case one way. Serious engine damage can result from an improperly positioned filter.

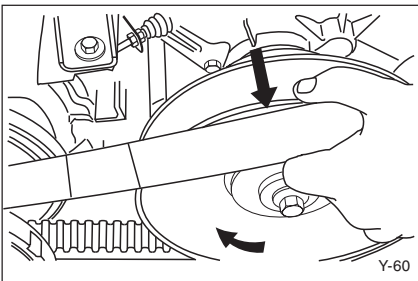

Drive Belt

To remove the drive belt:

1. Set the drive select lever halfway between forward and reverse.
2. Pull up on the drive belt and push it outward over the edge of the secondary sheave.
3. Turn the secondary sheave clockwise and the drive belt will roll off the sheave.
4. Remove the drive belt from the primary sheave.

MAINTENANCE

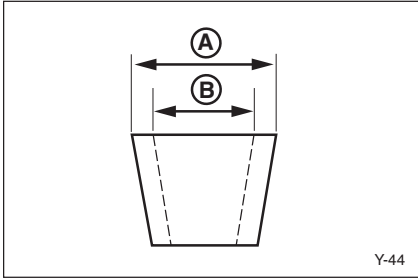

Inspection:

To inspect the drive belt, check for frayed edges or tears, and measure drive belt against the following specification. If the belt shows excessive wear or damage, replace the belt with a new one.

- (A) New: 31.0 mm (1.20 in.)
- (B) Replace when belt reaches: 27.0 mm (1.06 in.)

5. To install the drive belt, reverse the above steps, rolling the belt back over the secondary sheave.

Battery

The 12-volt battery that provides starting power to your gas car normally does not require the addition of water. If the battery loses its charge, have an experienced mechanic charge it.

⚠ WARNING

Battery electrolyte is poisonous and dangerous, causing severe burns, etc. It contains sulfuric acid. Avoid contact with skin, eyes, or clothing.

Antidote:

EXTERNAL: Flush with water.

INTERNAL: Drink large quantities of water or milk. Follow with milk of magnesia, beaten egg, or vegetable oil. Call physician immediately.

EYES: Flush with water for 15 minutes and get prompt medical attention.

Batteries produce explosive gases. Keep sparks, flame, cigarettes, etc., away.

Ventilate when charging or using in enclosed space. Always shield eyes when working near batteries.

KEEP OUT OF REACH OF CHILDREN.

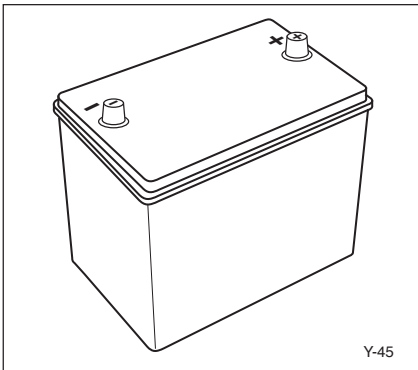

MAINTENANCE

Fuse Replacement

⚠ WARNING

Be sure to use the specified fuse. Using a wrong fuse can cause electrical system damage and create a fire hazard. Death or serious personal injury can result from failing to comply with the safety instructions in this manual.

NOTICE

When replacing a fuse, be sure the main switch is turned off to prevent accidental short-circuiting and electrical system damage.

1. Locate the in-line fuse holder on the main wire harness adjacent to the battery.
2. Pull fuse holder cover off.
3. Pull fuse out, inspect and replace if necessary.

- Ⓐ Fuse holder
- Ⓑ Fuse

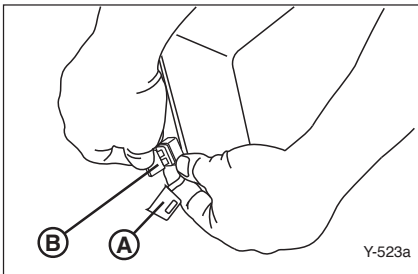

Fuse Type:
10 Amp, Blade Style

MAINTENANCE

Transaxle Oil

To check transaxle oil level:

1. Place the golf car on a flat, level surface.
2. Remove seven plastic rivets ① and two bolts ②, and remove the bag holder insert.
3. Place an oil pan under the transaxle case.
4. Clean area around servicing plug ④.
5. Using an 8 mm hex wrench, remove transaxle oil servicing plug located on the rear of the transaxle case.
6. Transaxle oil should be at the top of the oil servicing hole or just beginning to run out of hole.

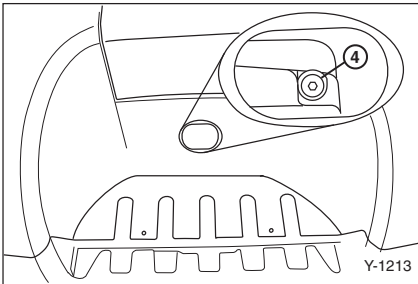
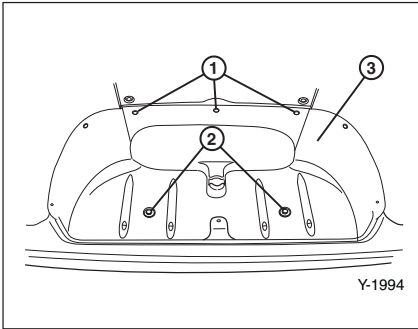

NOTICE

Do not allow foreign material to enter transaxle. Serious transaxle damage can result.

7. If needed, add Yamalube Friction Modified Shaft Drive Gear Oil until it is at the top of the plug hole or just beginning to run out of servicing hole.

TIP

The YDRA Golf Car is equipped with an internal wet brake. Use of oil other than Yamalube Friction Modified Shaft Drive Gear Oil will cause brake noise.

8. Install the transaxle servicing plug and tighten to 14-19 Nm, 1.4-1.9 m•kg (120-168 in•lb).
9. Install the bag holder insert ③ and secure with two bolts ② and seven plastic rivets ①.

MAINTENANCE

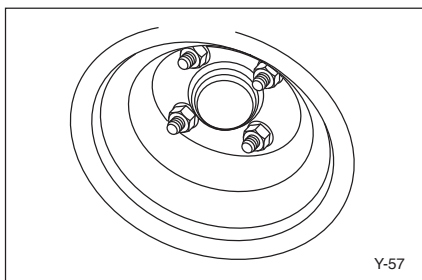

8

TIP

For transaxle oil replacement, consult a Yamaha dealer or other qualified mechanic.

NOTICE

Before performing wheel or brake maintenance, verify that the main switch is in the “OFF” position. Serious transaxle damage can result.

Wheel Replacement

To remove and install a wheel on your golf car:

1. With the wheels blocked to prevent the golf car from moving, loosen the wheel nuts.
2. Elevate the golf car with a jack and remove the wheel nuts and the wheel.
3. Reverse the removal steps when installing the wheel.

Wheel nut tightening torque:
88 Nm, 8.8 m·kg (65 ft·lb)

Brake Adjustment

The brakes on your golf car are self-adjusting.

Before you operate the car, press down on the brake pedal several times to make sure the brakes are functioning properly.

WARNING

Consult your Yamaha dealer before using your golf car if you suspect brake problems. Death or serious personal injury can result from failing to comply with the safety instructions in this manual.

MAINTENANCE

Brake Pedal Free Play Adjustment

NOTICE

Before adjusting brake pedal free play, pump the brake pedal several times to self-adjust the brakes.

To adjust the brake pedal free play:

1. Remove the floor mat and service lid from the floor of the golf car.
2. Check the brake pedal free play by pressing against the pedal with two fingers (using light force) and measuring the distance the pedal travels before resistance is felt.

Brake pedal free play (a):
45-50 mm (1.77-1.96 in.)

3. If the free play distance needs adjusting, loosen the lock nut (A) (under rubber boot) and turn the adjusting nut (B) in or out until the free play specification is met. Then tighten the lock nut in place.

NOTICE

Do not over-tighten the brake cables. Over-tightening will increase brake wear and affect overall performance of car. Premature brake wear can result.

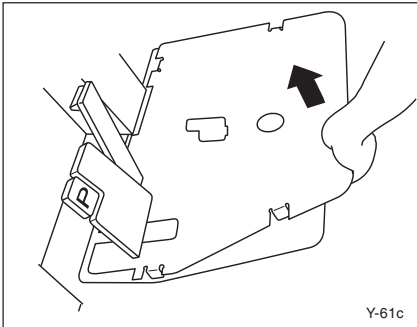

Y-61c

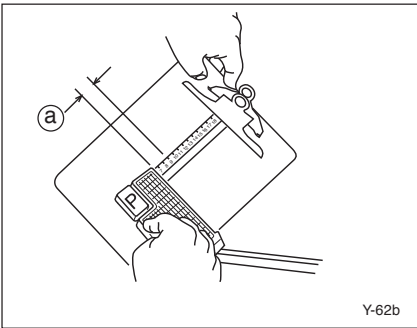

Y-62b

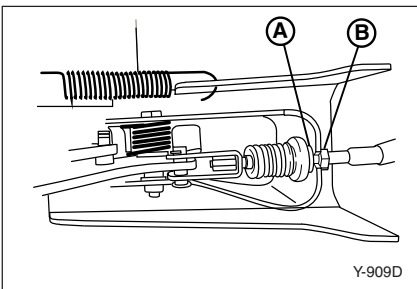

Y-909D

STORAGE

Perform the following preparations when storing your golf car for extended periods of time:

TIP

Turn main switch key to “OFF” position, remove key, and store key in a safe place.

DRAINING FUEL

⚠ WARNING

Gasoline and its vapors are highly flammable and explosive. Death or serious personal injury can result from failing to comply with the safety instructions in this manual.

- Do not smoke when draining fuel and keep away from sparks, flames, or other sources of ignition.
- Stop engine and allow it to cool for several minutes before draining fuel.
- Drain fuel in a well-ventilated area.
- Take care not to spill gasoline. If gasoline spills, wipe it up immediately with dry rags. Always dispose of gasoline-soaked rags properly.
- Tighten the filler cap securely after checking fuel level to avoid leaking.
- If you inhale a lot of gasoline vapor, or get gasoline in your eyes, get immediate medical attention.
- If any gasoline gets on your skin, immediately wash with soap and water. Change clothing if gasoline spills on it to avoid potential fire hazard.

1. Fill the fuel tank with fresh fuel and add the specified amount of Yamaha Fuel Stabilizer and Conditioner or equivalent product. Operate the vehicle for at least five minutes to distribute treated fuel through the fuel system.

Ⓐ Float bowl drain screw

2. Turn the fuel shutoff valve to the “CLOSED” position.
3. Drain the carburetor float chamber into a clean container by loosening the drain bolt; this will help prevent fuel deposits from building up. Pour the drained fuel into the fuel tank.

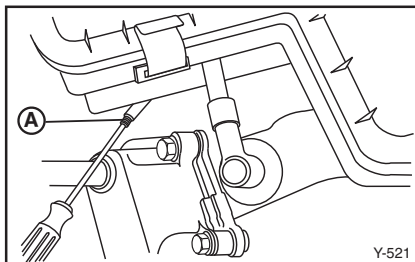

Specified amount:

7.5 cc of stabilizer for each liter of fuel (1 oz. of stabilizer for each gallon of fuel)

TIP

Use of fuel stabilizer and conditioner eliminates the need to drain the fuel system. Consult a Yamaha dealer if the fuel system needs to be drained instead.

ENGINE PREPARATION

With the key removed and the spark plug lead disconnected, turn the clutch by hand until compression is felt. This puts the valves in the closed position.

CHASSIS PREPARATION

1. Verify the tire pressure is set to 110 kPa, 1.1 kgf/cm² (16 psi).
2. Clean exterior of the golf car and apply a rust inhibitor.
3. Cover the golf car with a breathable cover and store it in a dry, well-ventilated area.

BATTERY PREPARATION

1. Remove the battery from the golf car and store it in a cool, dry place that stays between 0°C (32°F) and 30°C (90°F).

2. Have the battery recharged every 60-90 days to keep it fully charged. The battery must be kept fully charged to avoid damage.
3. Batteries like the one supplied with your car normally do not require you to check the water level inside the battery for the one-year warranty period provided by the manufacturer.

NOTICE

Do not allow cleaning solution to enter battery cells. Serious battery damage can result.

4. Clean the top of the battery with a solution of baking soda and water, as necessary, to remove corrosion.

SPECIFICATIONS

GENERAL SPECIFICATIONS

Items	YDRA
Dimensions:	
Overall length	2395 mm (94.3 in.)
Overall width	1200 mm (47.2 in.)
Overall height (steering height)	1190 mm (46.9 in.)
Height of floor	310 mm (12.2 in.)
Wheelbase	1640 mm (64.6 in.)
Tread:	
Front	870 mm (34.3 in.)
Rear	980 mm (38.6 in.)
Minimum ground clearance	110 mm (4.3 in.)
Weight:	
Dry weight (with suntop, without battery)	276 kg (609 lb)
Performance:	
Factory speed setting	19 km/h (12 mph)
Maximum speed	24 km/h (15 mph)
Minimum turning radius	2.8 m (9.2 ft)
Seating capacity	Two occupants per seat, four occupants maximum
Fuel Tank Capacity	22.0 L (5.8 U.S. Gallons)

PAINT CODES

Name	Ditzler Number
Glacier	918519
Emerald	48748
Garnet	701739
Tanzanite	917834
Onyx Metallic	918520
Anthracite Metallic	918522
Sandstone Metallic	918523

SPECIFICATIONS

ENGINE

Items	YDRA
Description:	
Engine type	4-stroke, Gasoline, 60° incline OHV
Number of cylinders	Single
Displacement	357 cm ³
Bore x stroke	85 x 63 mm (3.30 x 2.48 in.)
Compression ratio	8.1:1
Rated output	8.5 kw (11.4 hp)/3500 rpm
Cooling system	Forced air-cooled
Starting system	Starter
Ignition system	TCI Magneto
Spark plug type	BPR2ES
Spark plug gap	0.7-0.8 mm (0.028-0.031 in.)
Lubrication system	Splash-style positive oil lubrication
Engine oil type	YAMALUBE 4-cycle oil or 10W30
Engine oil capacity	1.0 L, 1000 cc (1.0 US qt)
Oil change quantity	1.0 L, 1000 cc (1.0 US qt)

TRANSMISSION

Items	YDRA
Transmission:	
Type	V-belt automatic centrifugal engagement
V-belt width and outer line length	31.0 x 1010 mm (1.20 x 39.76 in.)
V-belt wear limit	27.0 mm (1.06 in.)
Governor:	
Type	Oil bath flyweight
Factory speed setting	19 km/h (12 mph)
Differential/reduction gear:	
Differential type	Bevel gear
Lubricant/capacity	Yamalube Friction Modified Shaft Drive Gear Oil / 1750 mL (1.85 quarts total). Alternative lubricant is mixture of 1660 mL (1.75 quarts) 80W90 Gear Oil and 90 mL (0.10 quarts) API G15 Limited Slip Additive.

SPECIFICATIONS

BATTERIES

Items	YDRA
Battery:	BCI group 24, RC: minimum 75 min CCA: minimum 400A

CHASSIS

Items	YDRA
Steering system: Type Steering angle (L.H.) Steering angle (R.H.)	Rack and Pinion 1.85 turn 1.85 turn
Brakes: Brake system Type of brake Brake pedal free play linkage adjustment (Brake cable end play)	Mechanical Maintenance-Free internal transaxle disc brake 45-50 mm (1.77-1.96 in.) 0.1-0.5 mm (0.004-0.02 in.)
Parking brake: Type	Foot type; parking brake with automatic release.
Release timing (With pedal segment in second notch) (Bolt heads round parallel to arm)	0.0 ~ 0.3 mm (0.000 ~ 0.001 in.)
Wheel: Tire size: Front Rear Rim size: Tire pressure:	18 x 8.50-8.00/4 PR 18 x 8.50-8.00/4 PR 7.00-1-8.00 110 kPa, 1.1 kgf/cm ² (16 psi)

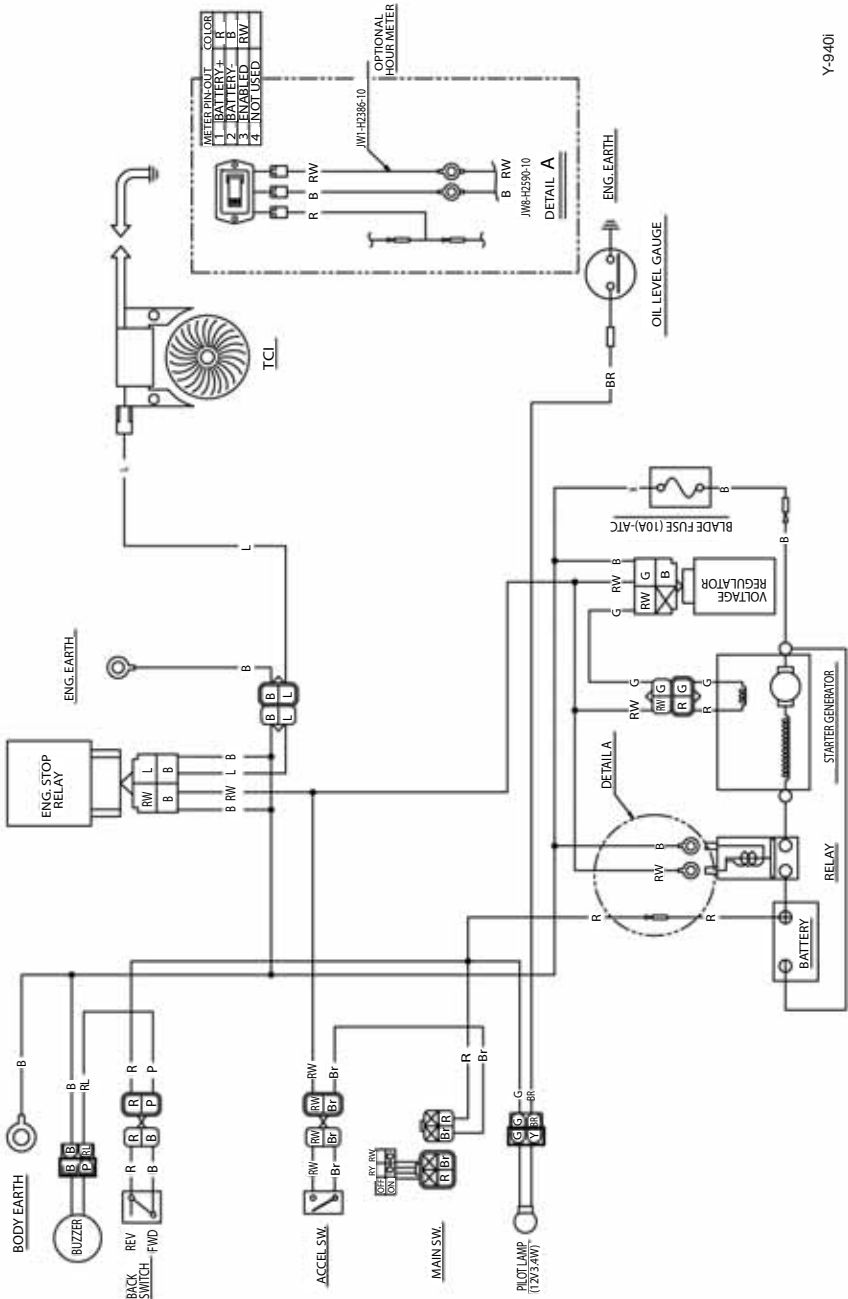

Y-9401

NOTES

NOTES

NOTES



Printed in U.S.A
2012-KCC

YAMAHA GOLF-CAR
COMPANY
1000 HWY 34 East
Newnan, GA 30265
770-254-4000